

PART No. RCHS1900817

for more information visit  
[www.hammfg.com](http://www.hammfg.com)

Data subject to change without notice.  
Isometric drawing not to scale.  
Shipped knockdown for handling ease  
& protection.



TOP VIEW

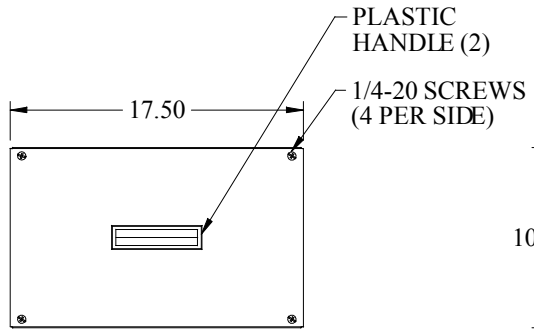
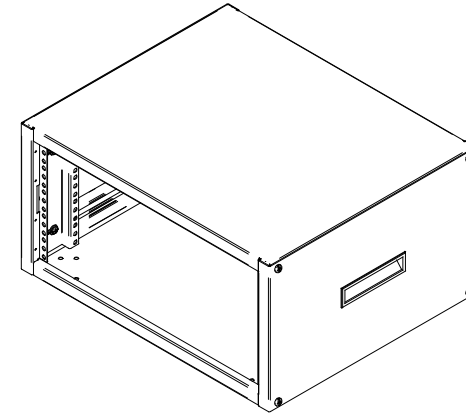

L.S. VIEW

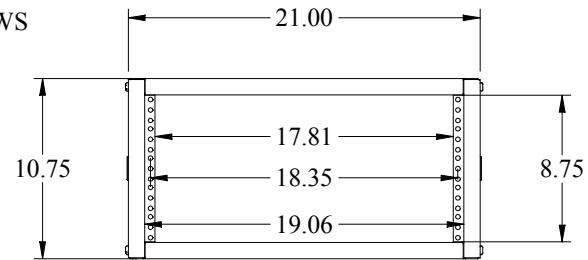

FRONT VIEW

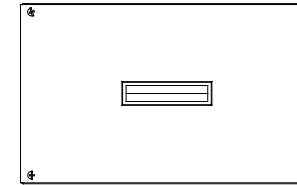

R.S. VIEW

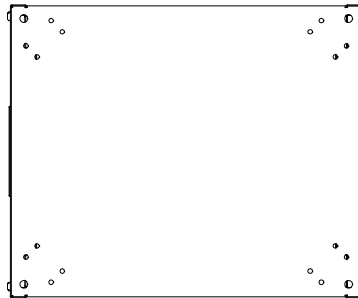

BOTTOM VIEW